

RIS P EKO

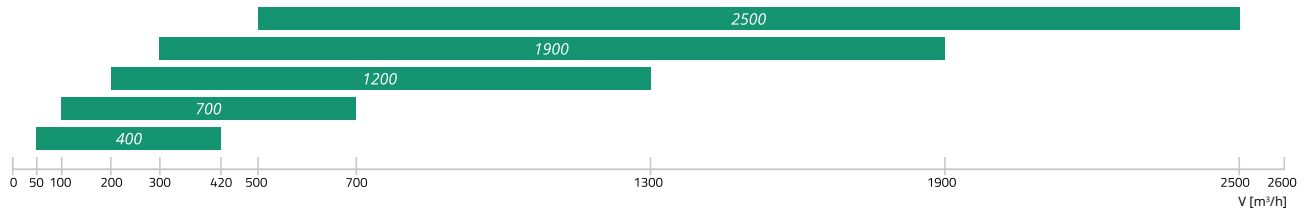

AIR HANDLING UNITS

Application	Ventilation of houses, offices or other heated premises (classrooms, apartments, conference rooms, etc.)
Description	<p>RIS P EKO 3.0 is a range of heat recovery units with high-efficiency counter-flow heat exchangers and low height. The units are designed for mounting under ceilings in order to save space. There are 5 sizes (airflow interval 420-2500 m³/h) with separate heaters available for different climate zones.</p> <p>RIS P EKO 3.0 units have high overall energy savings due to the highly efficient heat recovery (up to 90%), quiet and economical EC fans, effective low-pressure-drop filters, 100% motorized bypass dampers (for the 1900 and 2500 versions) and top-level of air tightness.</p> <p>Energy efficiency ensures full thermal comfort for passive houses, without an additional pre-heater at temperatures above -5°C.</p> <p>All the RIS P EKO 3.0 units are fully equipped with automatic controls. Optional external sensors for CO₂ and humidity and the event planning feature will help to control automatically your climate (demand-level control). RIS P EKO 3.0 units are service-friendly and are easy to mount. Filter pollution may be identified by timers or contamination controls (RIS 1200-2500 P EKO 3.0). All units are supplied tested and ready to install.</p>
Remote control	<p>Three remote control options are available:</p> <ol style="list-style-type: none"> 1. Flex, Stouch or Ptouch remote controllers. 2. Building management system connections. 3. Remote control via PC MB-Gateway.
Features	<ul style="list-style-type: none"> › Ideal for ceiling installations. › Ready for Passive House technology: high efficiency. › Easy and quick mounting. › Water/electrical heating options. › Fully integrated plug-and-play control system.
Construction	<ul style="list-style-type: none"> › Frameless construction from double-skinned panels. › Acoustic and thermal wall insulation: RIS 400-2500 P EKO 3.0 - 30/50 mm. › RIS 400-700 P EKO 3.0 powder-coated white housing RAL 9016; RIS 1200-2500 P EKO 3.0 powder-coated grey housing RAL 7040. › Integrated electrical heater or optional duct-based water heater/cooler. › Low-pressure-drop filters: F7/M5. › Hinged door with locks grants easy access to internal components. › Separate compartment on the side of the unit grants quick access to the control board (plug-and-play). › Stainless steel condensate tray. › Fitted with mounting brackets. › Integrated anti-frost pressure switch (RIS 1200-2500 P EKO 3.0).

RIS 400 P E 0.9 EKO 3.0

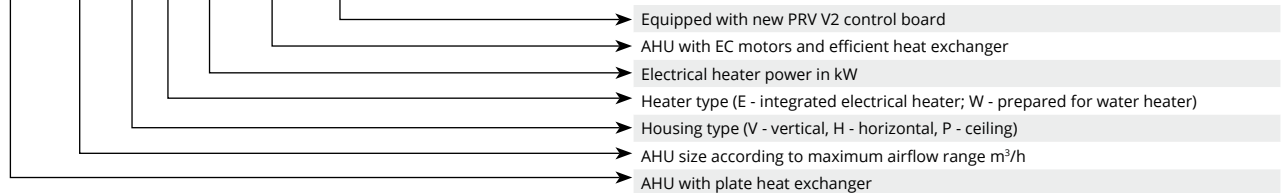

RIS 400P EKO - RIS 700P EKO 3.0

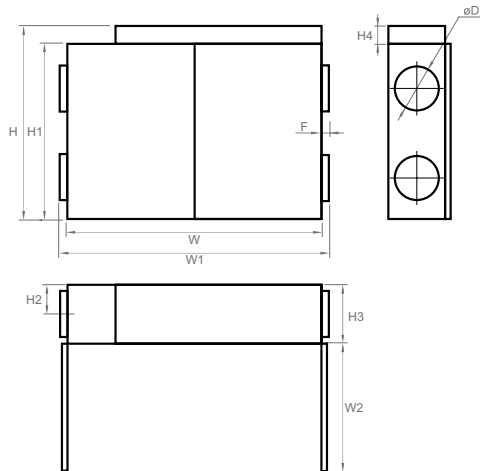

RIS 1200P EKO - RIS 2500P EKO 3.0

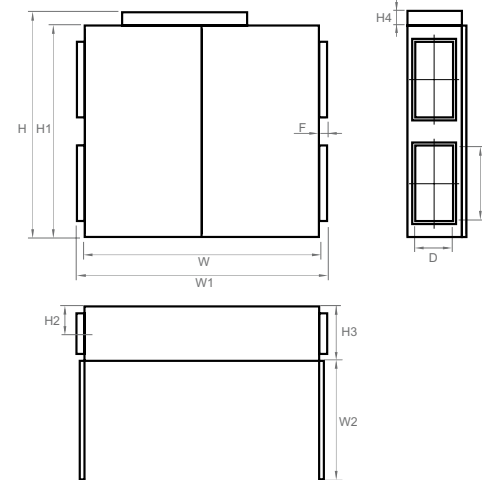























Unit	Dimensions [mm]											
	W	W1	W2	H	H1	H2	H3	H4	F	ØD	G	D
RIS 400PE/PW EKO 3.0	1300	1361	650	768	670	158	330	98	31	200	-	-
RIS 700PE/PW EKO 3.0	1380	1461	695	1069	970	160	350	99	40	250	-	-
RIS 1200PE/PW EKO 3.0	1550	1655	780	1497	1397	172	390	100	52	-	500	250
RIS 1900PE/PW EKO 3.0	1750	1870	710	1955	1850	194	399	105	60	-	700	300
RIS 2500PE/PW EKO 3.0	1850	1970	720	2055	1950	244	499	105	60	-	700	400

Unit	Optional accessories													
	Flex Stouch Ptouch MB-Gateway	S-1141 S-RC02-F2 S-KFF-U	SSB Heating	SSB Cooling	SP Supply	SP Exhaust	SVS	SSK SKS	RMG	VVP/VXP	SKG AKS AP	AVS AVA EKA NV PH	EKS NV PH	
RIS 400PE EKO 3.0	+	+	-	81	CM230-1-F-L	CM230-1-F-L	-	-	-	-	200	200	-	
RIS 400PW EKO 3.0	+	+	61	81	TF230	CM230-1-F-L	-	-	+	+	200	200	-	
RIS 700PE EKO 3.0	+	+	-	81	CM230-1-F-L	CM230-1-F-L	-	-	-	-	250	250	-	
RIS 700PW EKO 3.0	+	+	61	81	TF230	CM230-1-F-L	-	-	+	+	250	250	-	
RIS 1200PE EKO 3.0	+	+	-	-	LM230A-TP	LM230A-TP	-	500x250	-	-	-	-	500x250	
RIS 1200PW EKO 3.0	+	+	61	-	NF230A	LM230A-TP	500x250	500x250	+	+	-	-	500x250	
RIS 1900PE EKO 3.0	+	+	-	-	LM230A-TP	LM230A-TP	-	700x400*	-	-	-	-	700x400*	
RIS 1900PW EKO 3.0	+	+	61	-	NF230A	LM230A-TP	700x400*	700x400*	+	+	-	-	700x400*	
RIS 2500PE EKO 3.0	+	+	-	-	LM230A-TP	LM230A-TP	-	700x400	-	-	-	-	700x400	
RIS 2500PW EKO 3.0	+	+	61	-	NF230A	LM230A-TP	700x400	700x400	+	+	-	-	700x400	

*necessary to order flange adapter STP 700x400-700x300

Accessories

Network Module  MB-Gateway p. 178	Remote controller  Ptouch p. 175	Control panel  FLEX p. 177	Remote controller  Stouch p. 176	Pressure transmitter  S-1141 p. 179	CO2 sensor  S-RC02-F2 p. 180		
Humidity sensor  S-KFF-U p. 181	Thermic water valve actuator  SSB p. 195	Actuator for dampers  SP p. 210	Water heater coil  SVS p. 190	Damper for rectangular duct  SSK p. 213	Rectangular duct silencer  SKS p. 215	Shut-off damper  SKG p. 212	Circular duct silencer  AKS p. 216
Mounting clamps  AP p. 219	Heating coil  AVS p. 185	Circular duct water cooler  AVA p. 193	Electrical duct pre-heater  EKS NV PH p. 203	Electrical duct pre-heater  EKA NV PH p.201	Mixing point  RMG p. 196	2 and 3 way valves  VVP/VXP p. 197	Flange adapter  STP p. 220

RIS P EKO

RIS 400PE EKO 3.0

Supply air

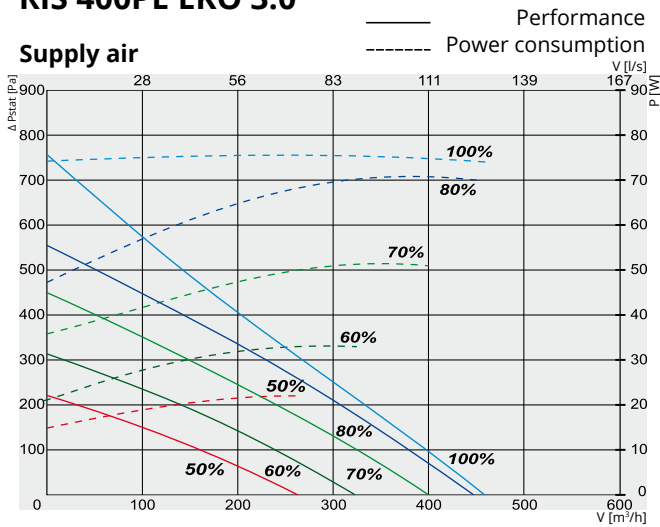

Exhaust air

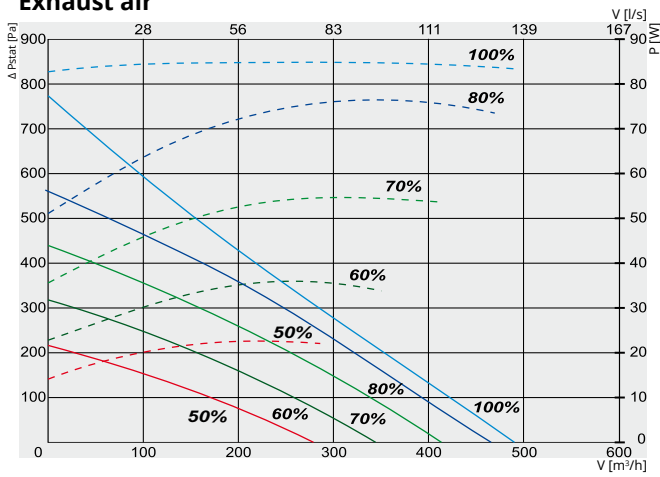

Specific fan power

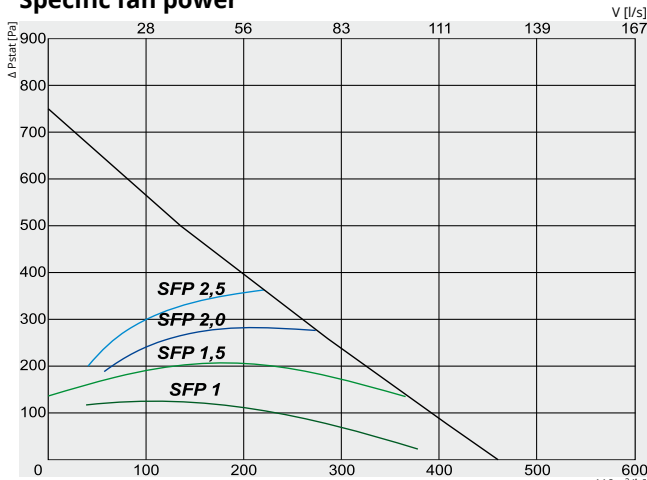

Temperature efficiency

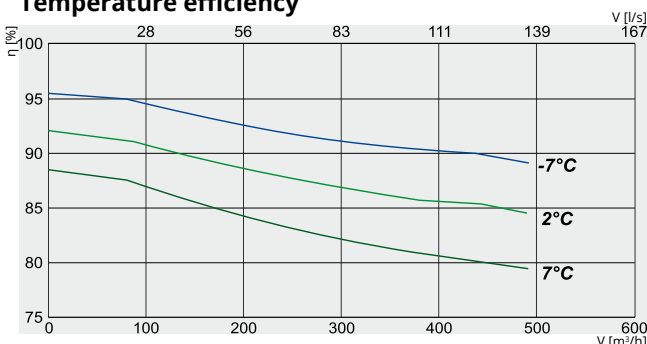

RIS 400PE EKO 3.0

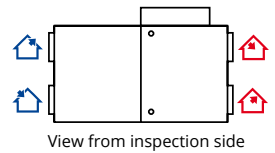

View from inspection side

➡ Exhaust air
 ➡ Extract air
 ➡ outdoor air
 ➡ Supply air

Article No.	Version
GAGRIS1747_0017A	400PE 0.9 EKO 3.0 Integrated electrical heater
GAGRIS1746_0017A	400PE 1.6 EKO 3.0 Integrated electrical heater
GAGRIS1692_0016A	400PE 3.0 EKO 3.0 Integrated electrical heater

		0.9 EKO 3.0	1.6 EKO 3.0	3.0 EKO 3.0
Electrical heater	phase/voltage [50Hz/VAC]	~1, 230	~1, 230	~1, 230
	[kW]	0,9	1,6	3,0
EC fans	phase/voltage [50Hz/VAC]	~1, 230		
	exhaust power/current [kW/A]	0,085/0,73		
	fan speed [min ⁻¹]	3200		
supply	power/current [kW/A]	0,085/0,73		
	fan speed [min ⁻¹]	3200		
Thermal efficiency up to*		90%		
Motorized by-pass		+		
Max power consumption	[kW/A]	1,07/5,50	1,77/8,50	3,17/14,50
Control board		PRV V2		
Filter class	exhaust/supply	M5/F7		
Housing insulation, mineral wool	[mm]	30		
Colour	RAL	white 9016		
Weight (net, without packing)	[kg]	74		
Comply with ERP		2016; 2018		
Operation		indoors		
Fresh air temperature limits**	°C	-5 - +40		
Housing protection class	IP	34		

* Calculated according EN 13141-7.

**For temperatures lower than recommended, use electrical pre-heater to ensure balanced operation.

Temperature efficiency (balanced mass flow) EN 13141-7:
 Extract air = 20°C/60%RH
 Outdoor air = -7°C / 2°C / 7°C

RIS 400PE EKO 3.0	Lwa total, dB(A)	LWA, dB(A)						
		125 Hz	250 Hz	500 Hz	1 kHz	2 kHz	4 kHz	8 kHz
Supply	67	54	59	64	58	57	54	47
Extract	58	48	50	53	51	48	46	41
Surrounding	51	40	43	46	45	40	39	36

Measured at 395 m³/h, 100 Pa

Certifications

EUROVENT certified
 heat exchanger performance



RIS 400PW EKO 3.0

Supply air

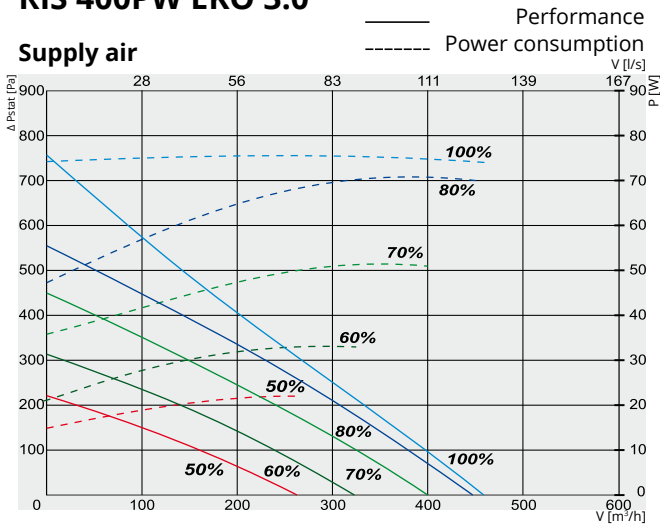

Exhaust air

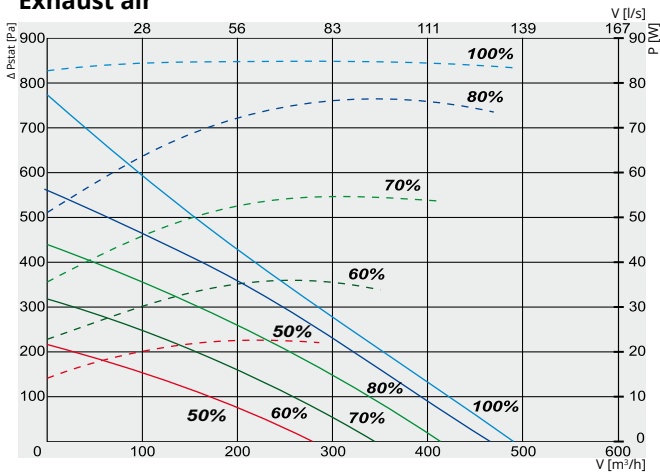

Specific fan power

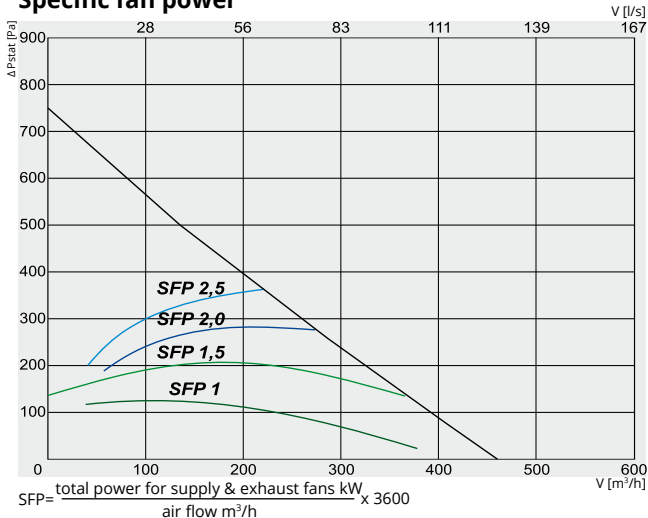

Temperature efficiency

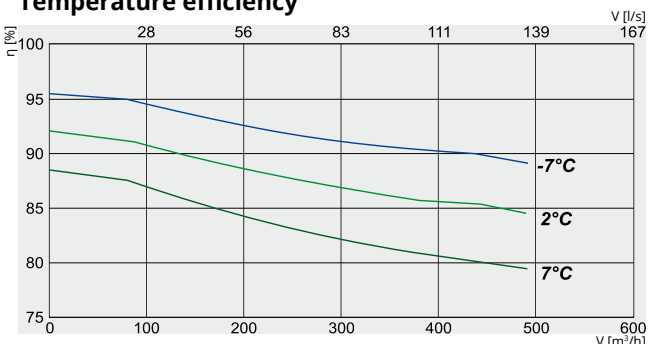

RIS 400PW EKO 3.0

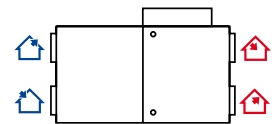

View from inspection side

🏠 Exhaust air
 🏠 Extract air
 🏠 outdoor air
 🏠 Supply air

Article No. GAGRIS1748_0019A Version 400PW EKO 3.0 Optional water heater

400PW EKO 3.0

Water heater (optional)	AVS 200		
Fans	phase/voltage	[50Hz/VAC]	~1, 230
exhaust	power/current	[kW/A]	0,085/0,73
	fan speed	[min ⁻¹]	3200
supply	power/current	[kW/A]	0,085/0,73
	fan speed	[min ⁻¹]	3200
Thermal efficiency up to*	90%		
Motorized by-pass	+		
Max power consumption	[kW/A]	0,17/1,50	
Control board	PRV V2		
Filter class	exhaust/supply	M5/F7	
Housing insulation, mineral wool	[mm]	30	
Colour	RAL	white	9016
Weight (net, without packing)	[kg]	73	
Comply with ERP	2016; 2018		
Operation	indoors		
Fresh air temperature limits**	°C	-5 - +40	
Housing protection class	IP	34	

* Calculated according EN 13141-7.

**For temperatures lower than recommended, use electrical pre-heater to ensure balanced operation.

Temperature efficiency (balanced mass flow) EN 13141-7:
 Extract air = 20°C/60%RH
 Outdoor air = -7°C / 2°C / 7°C

RIS 400PW EKO 3.0	Lwa total, dB(A)	LWA, dB(A)						
		125 Hz	250 Hz	500 Hz	1 kHz	2 kHz	4 kHz	8 kHz
Supply	67	54	59	64	58	57	54	47
Extract	58	48	50	53	51	48	46	41
Surrounding	51	40	43	46	45	40	39	36

Measured at 395 m³/h, 100 Pa

Certifications

EUROVENT certified
 heat exchanger performance



RIS P EKO

RIS 700PE EKO 3.0

Supply air

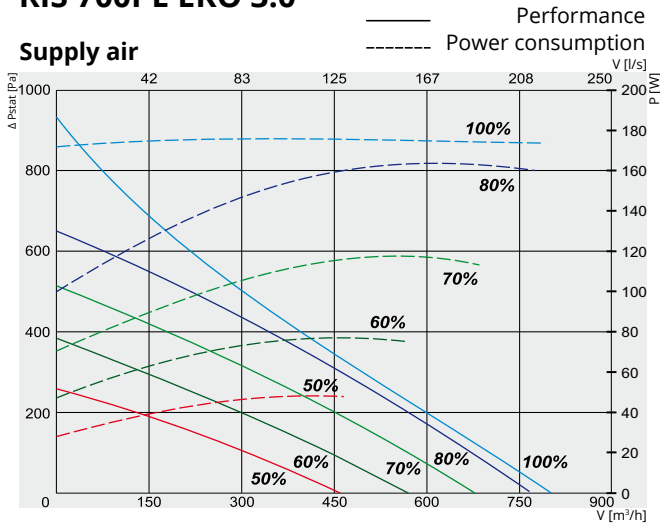

Exhaust air

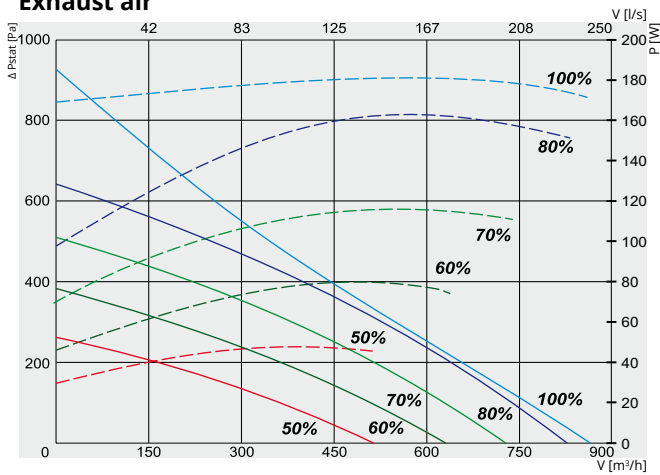

Specific fan power

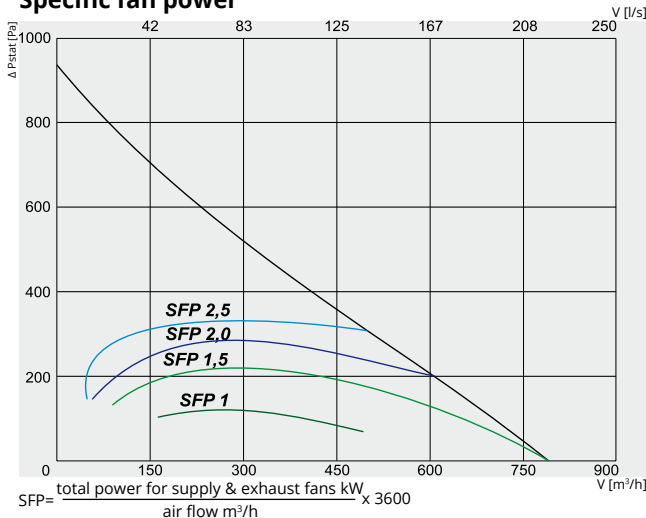

Temperature efficiency

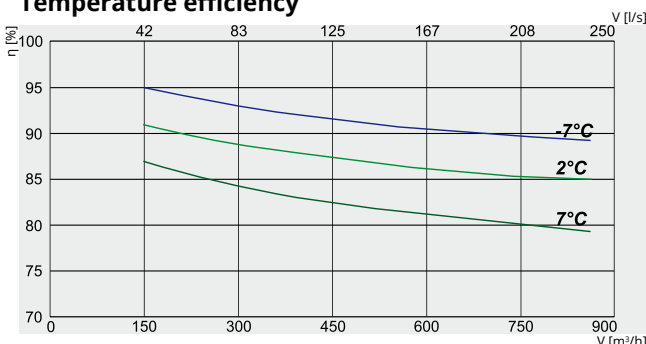

RIS 700PE EKO 3.0

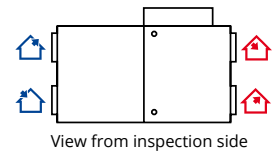

Article No.	Version	Version
GAGRIS1737_0008A	700PE 1.2 EKO 3.0	Integrated electrical heater
GAGRIS1736_0007A	700PE 3.0 EKO 3.0	Integrated electrical heater
GAGRIS1693_0005B	700PE 4.5 EKO 3.0	Integrated electrical heater

		1.2 EKO 3.0	3.0 EKO 3.0	4.5 EKO 3.0
Electrical heater	phase/voltage [50Hz/VAC]	~1, 230	~1, 230	~3, 400
	[kW]	1,2	3,0	4,5
EC fans	phase/voltage [50Hz/VAC]	~1, 230		
exhaust	power/current [kW/A]	0,168/1,4		
	fan speed [min ⁻¹]	3230		
supply	power/current [kW/A]	0,168/1,4		
	fan speed [min ⁻¹]	3230		
Thermal efficiency up to*		90%		
Motorized by-pass		+		
Max power consumption	[kW/A]	1,54/8,34	3,34/15,84	4,84/9,3
Control board		PRV V2		
Filter class	exhaust/supply	M5/F7		
Housing insulation, mineral wool	[mm]	30		
Colour	RAL	white		
		9016		
Weight (net, without packing)	[kg]	103,5	104	104,5
Comply with ERP		2016;2018		
Operation		indoors		
Fresh air temperature limits**	°C	-5 - +40		
Housing protection class	IP	34		

* Calculated according EN 13141-7.

**For temperatures lower than recommended, use electrical pre-heater to ensure balanced operation.

Temperature efficiency (balanced mass flow) EN 13141-7:
Extract air = 20°C/60%RH
Outdoor air = -7°C / 2°C / 7°C

RIS 700PE EKO 3.0	Lwa total, dB(A)	125 Hz	250 Hz	500 Hz	1 kHz	2 kHz	4 kHz	8 kHz
Supply	75	64	66	68	70	66	60	59
Extract	62	53	55	57	56	52	49	45
Surrounding	56	45	47	50	50	47	43	42

Measured at 700 m³/h, 100 Pa

Certifications

EUROVENT certified
heat exchanger performance



RIS 700PW EKO 3.0

Supply air

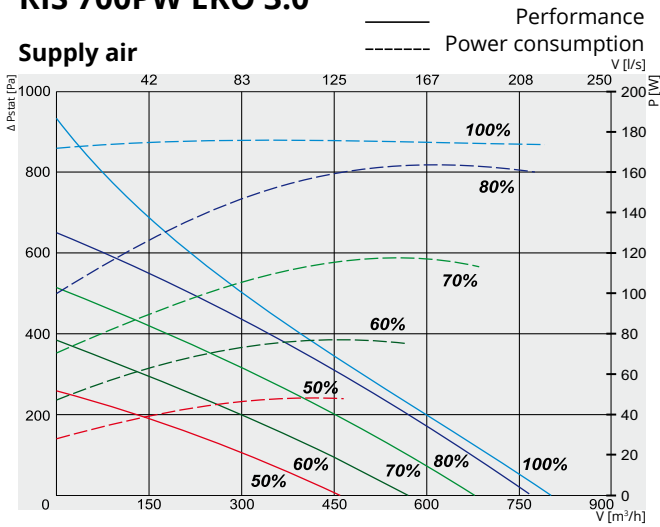

Exhaust air

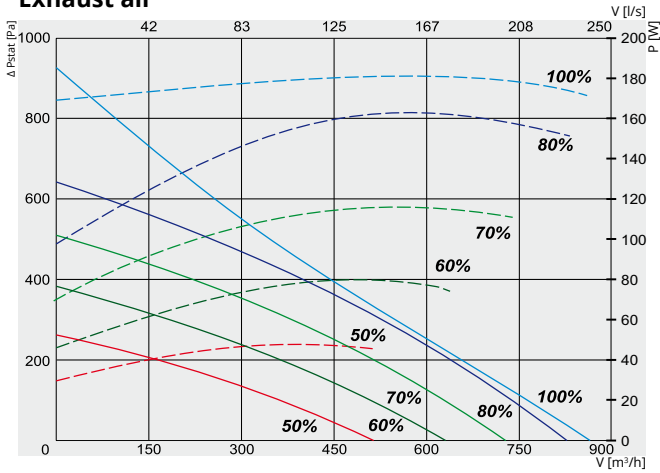

Specific fan power

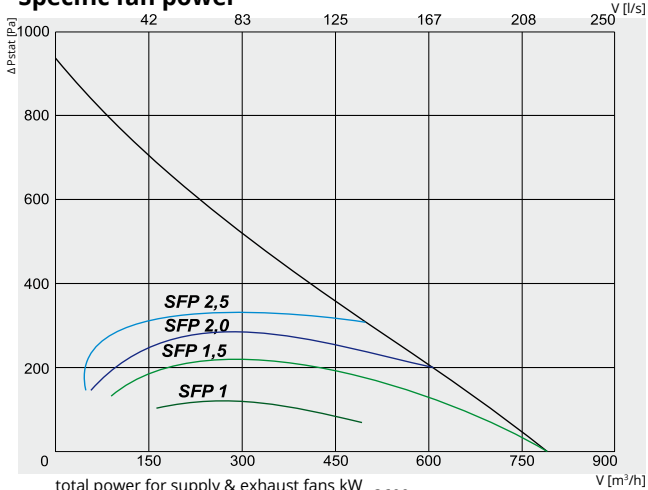

$$SFP = \frac{\text{total power for supply \& exhaust fans kW}}{\text{air flow m}^3/\text{h}} \times 3600$$

Temperature efficiency

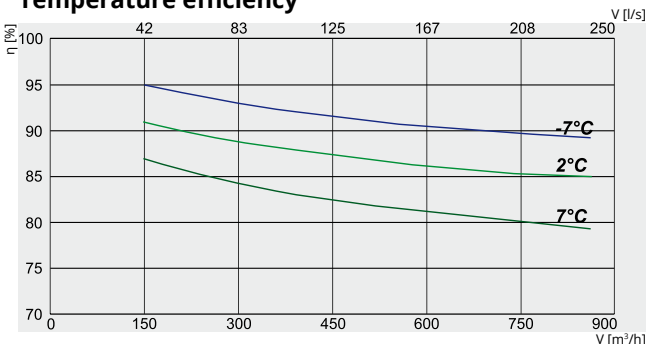

RIS 700PW EKO 3.0

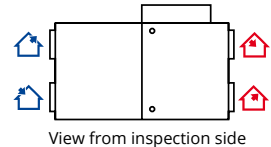

View from inspection side

🏠 Exhaust air
 🏠 Extract air
 🏠 outdoor air
 🏠 Supply air

Article No. GAGRIS1738_0009A Version 700PW EKO 3.0 Optional water heater

700PW EKO 3.0

Water heater (optional)	AVS 250		
Fans	phase/voltage	[50Hz/VAC]	~1,230
exhaust	power/current	[kW/A]	0,168/1,4
	fan speed	[min ⁻¹]	3230
supply	power/current	[kW/A]	0,168/1,4
	fan speed	[min ⁻¹]	3230
Thermal efficiency up to*	90%		
Motorized by-pass	+		
Max power consumption	[kW/A]	0,34/2,84	
Control board	PRV V2		
Filter class	exhaust/supply	M5/F7	
Housing insulation, mineral wool	30		
Colour	RAL	white	9016
Weight (net, without packing)	[kg]	103	
Comply with ERP	2016;2018		
Operation	indoors		
Fresh air temperature limits**	°C	-5 - +40	
Housing protection class	IP	34	

* Calculated according EN 13141-7.

**For temperatures lower than recommended, use electrical pre-heater to ensure balanced operation.

Temperature efficiency (balanced mass flow) EN 13141-7:
 Extract air = 20°C/60%RH
 Outdoor air = -7°C / 2°C / 7°C

RIS 700PW EKO 3.0	Lwa total, dB(A)	LWA, dB(A)						
		125 Hz	250 Hz	500 Hz	1 kHz	2 kHz	4 kHz	8 kHz
Supply	75	64	66	68	70	66	60	59
Extract	62	53	55	57	56	52	49	45
Surrounding	56	45	47	50	50	47	43	42

Measured at 700 m³/h, 100 Pa

Certifications

EUROVENT certified
 heat exchanger performance



RIS P EKO

RIS 1200PE EKO 3.0

Supply air

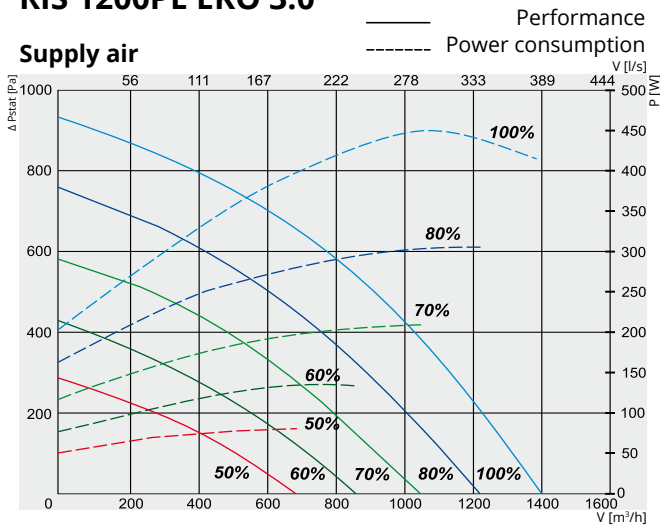

Exhaust air

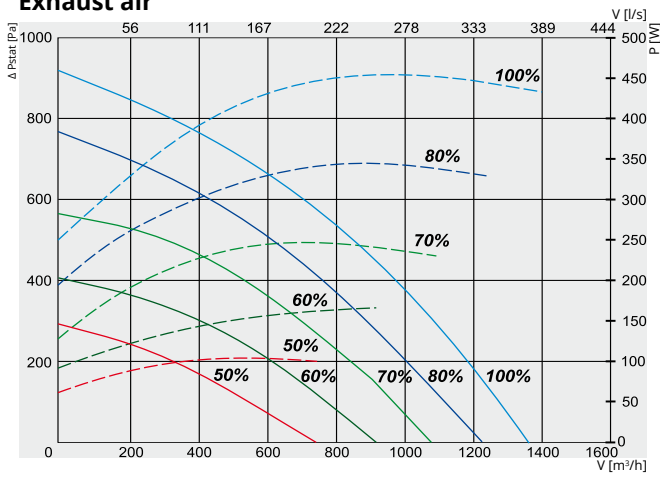

Specific fan power

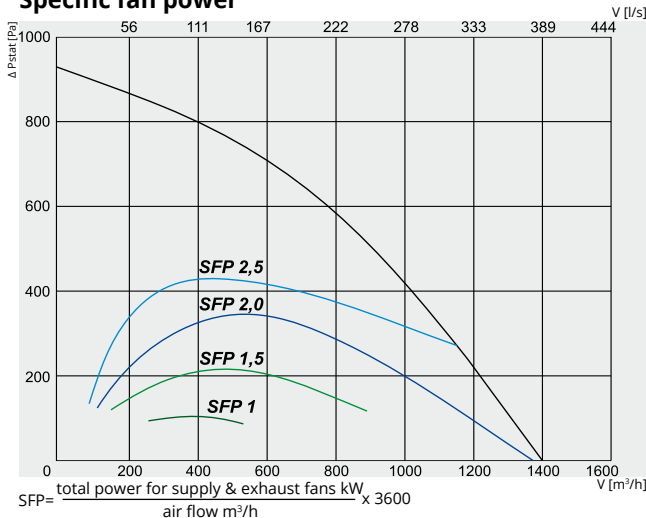

Temperature efficiency

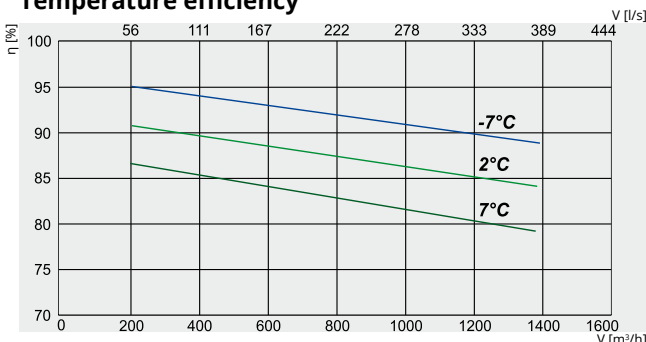

RIS 1200PE EKO 3.0

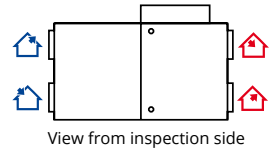

- Exhaust air
- Extract air
- outdoor air
- Supply air

Article No.	Version
GAGRIS1744_0022A	1200PE 3.0 EKO 3.0 Integrated electrical heater
GAGRIS1745_0021B	1200PE 6.0 EKO 3.0 Integrated electrical heater
GAGRIS1701_0020B	1200PE 9.0 EKO 3.0 Integrated electrical heater

		3.0 EKO 3.0	6.0 EKO 3.0	9.0 EKO 3.0
Electrical heater	phase/voltage [50Hz/VAC]	~1, 230	~3, 400	~3, 400
	[kW]	3,0	6,0	9,0
EC fans	phase/voltage [50Hz/VAC]	~1,230		
	power/current [kW/A]	0,450/2,95		
exhaust	fan speed [min ⁻¹]	3400		
	power/current [kW/A]	0,370/2,5		
supply	fan speed [min ⁻¹]	3400		
	Thermal efficiency up to*	90%		
Motorized by-pass		+		
Max power consumption	[kW/A]	3,82/18,49	6,82/14,19	9,82/18,49
Control board		PRV V2		
Filter class	exhaust/supply	M5/F7		
Housing insulation, mineral wool	[mm]	50		
Colour	RAL	grey 7040		
Weight (net, without packing)	[kg]	170		
Comply with ERP		2016;2018		
Operation		indoors		
Fresh air temperature limits**	°C	-5 - +40		
Housing protection class	IP	34		

* Calculated wet efficiency.
 **For temperatures lower than recommended, use electrical pre-heater to ensure balanced operation.

Temperature efficiency (balanced mass flow) :
 Extract air = 20°C/60%RH
 Outdoor air = -7°C / 2°C / 7°C

RIS 1200PE EKO 3.0	Lwa total, dB(A)	125 Hz	250 Hz	500 Hz	1 kHz	2 kHz	4 kHz	8 kHz
Supply	76	58	69	71	69	67	64	56
Extract	64	52	56	61	56	50	45	42
Surrounding	56	42	48	50	49	48	46	40

Measured at 1298 m³/h, 100 Pa

Certifications

EUROVENT certified
 heat exchanger performance



RIS 1200PW EKO 3.0

Supply air

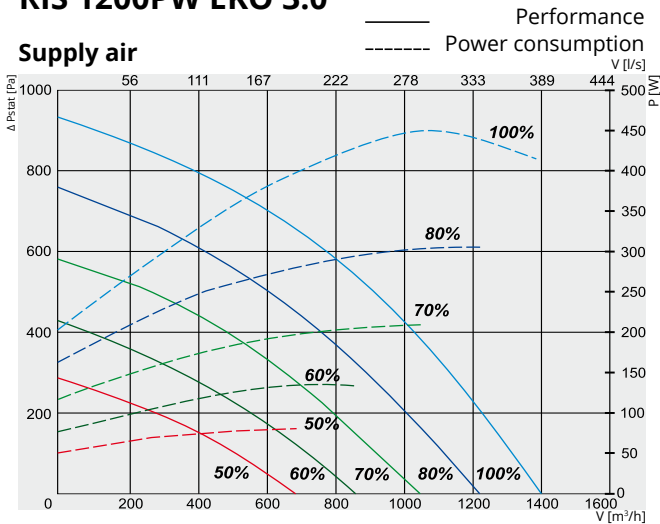

Exhaust air

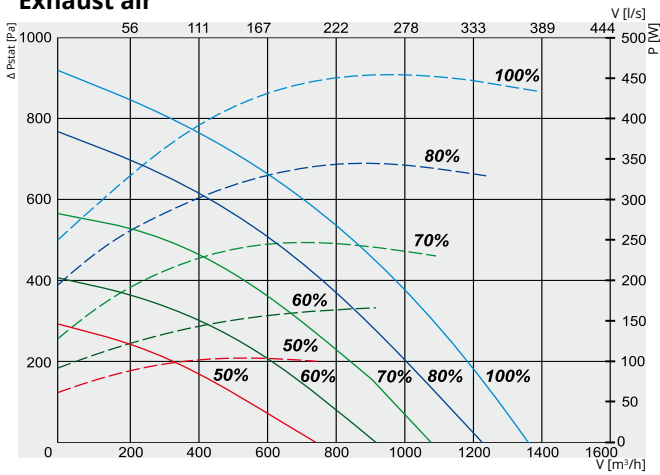

Specific fan power

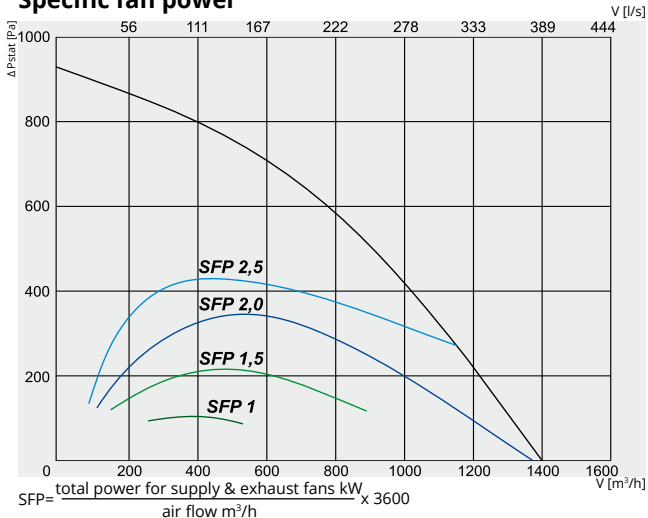

Temperature efficiency

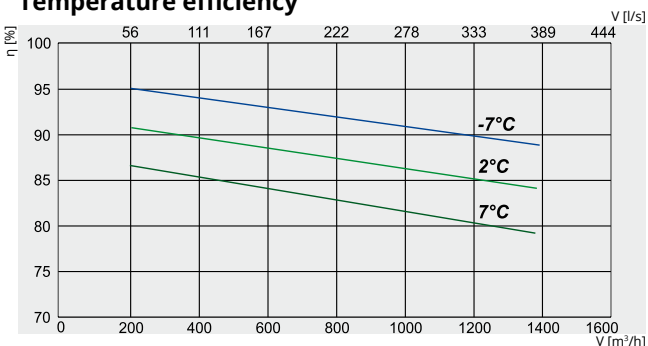

RIS 1200PW EKO 3.0

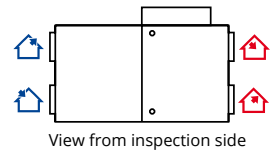

🏠 Exhaust air
 🏠 Extract air
 🏠 outdoor air
 🏠 Supply air

Article No. GAGRIS1721_0023A Version 1200PW EKO 3.0 Optional water heater

1200PW EKO 3.0

Water heater (optional)	SVS 500x250		
Fans	phase/voltage	[50Hz/VAC]	~1,230
exhaust	power/current	[kW/A]	0,450/2,95
	fan speed	[min ⁻¹]	3400
supply	power/current	[kW/A]	0,370/2,5
	fan speed	[min ⁻¹]	3400
Thermal efficiency up to*	90%		
Motorized by-pass	+		
Max power consumption	[kW/A]	0,82/5,49	
Control board	PRV V2		
Filter class	exhaust/supply	M5/F7	
Housing insulation, mineral wool	[mm]	50	
Colour	RAL	grey	7040
Weight (net, without packing)	[kg]	170	
Comply with ERP	2016;2018		
Operation	indoors		
Fresh air temperature limits**	°C	-5 - +40	
Housing protection class	IP	34	

* * Calculated wet efficiency.

**For temperatures lower than recommended, use electrical pre-heater to ensure balanced operation.

Temperature efficiency (balanced mass flow) EN :
Extract air = 20°C/60%RH
Outdoor air = -7°C / 2°C / 7°C

RIS 1200PE EKO 3.0	Lwa total, dB(A)	125 Hz	250 Hz	500 Hz	1 kHz	2 kHz	4 kHz	8 kHz
Supply	76	58	69	71	69	67	64	56
Extract	64	52	56	61	56	50	45	42
Surrounding	56	42	48	50	49	48	46	40

Measured at 1298 m³/h, 100 Pa

Certifications

EUROVENT certified
heat exchanger performance



RIS P EKO

RIS 1900PE EKO 3.0

Supply air

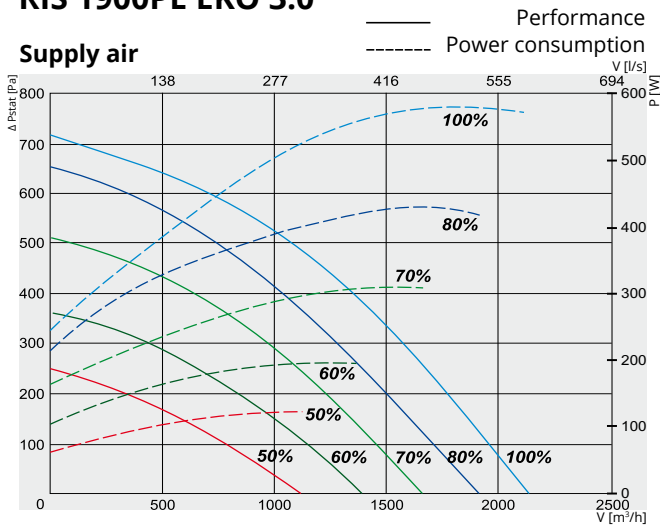

Exhaust air

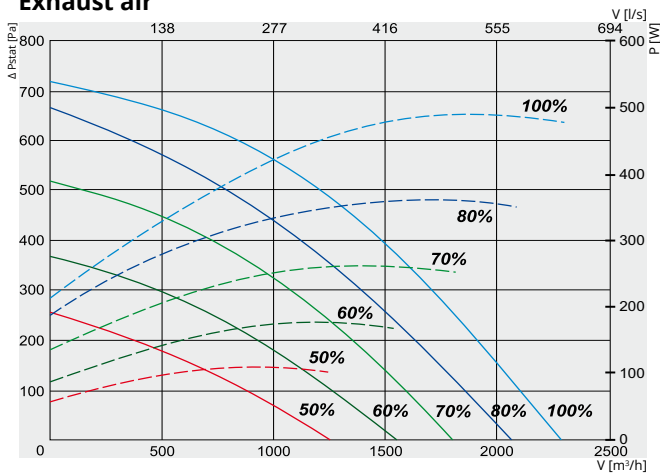

Specific fan power

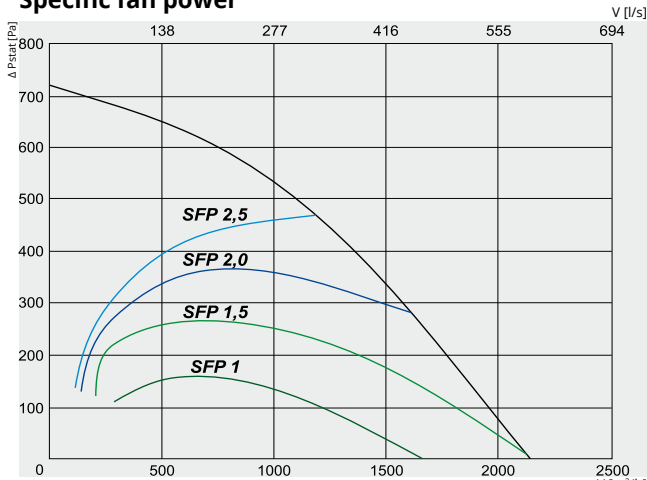

Temperature efficiency

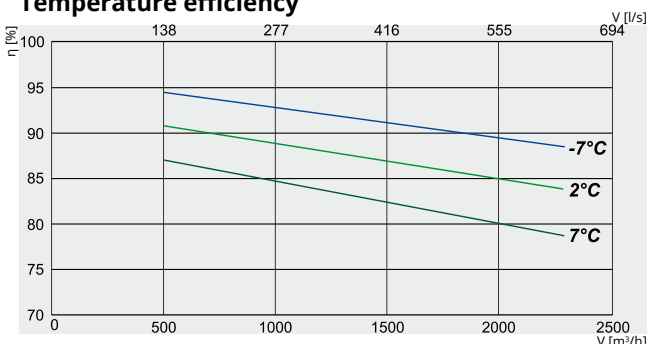

RIS 1900PE EKO 3.0

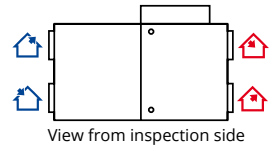

🏠 Exhaust air
 🏠 Extract air
 🏠 outdoor air
 🏠 Supply air

Article No.	Version
GAGRIS1751_0025A	1900PE 3.0 EKO 3.0 Integrated electrical heater
GAGRIS1752_0024B	1900PE 6.0 EKO 3.0 Integrated electrical heater
GAGRIS1706_0001B	1900PE 12.0 EKO 3.0 Integrated electrical heater

		3.0 EKO 3.0	6.0 EKO 3.0	12.0 EKO 3.0
Electrical heater	phase/voltage [50Hz/VAC]	~1, 230	~3, 400	~3, 400
	[kW]	3,0	6,0	12,0
EC fans	phase/voltage [50Hz/VAC]	~1, 230		
	power/current [kW/A]	0,485/3,12		
exhaust	fan speed [min ⁻¹]	2540		
	power/current [kW/A]	0,488/3,16		
supply	fan speed [min ⁻¹]	2540		
	power/current [kW/A]	0,488/3,16		
Thermal efficiency up to*		90%		
Motorized by-pass		+		
Max power consumption	[kW/A]	3,97 /20,32	6,97 /14,92	12,97 /24,32
Control board		PRV V2		
Filter class	exhaust/supply	M5/F7		
Housing insulation, mineral wool	[mm]	50		
Colour	RAL	grey	7040	
Weight (net, without packing)	[kg]	269	270	272
Comply with ERP		2016;2018		
Operation		indoors		
Fresh air temperature limits**	°C	-5 - +40		
Housing protection class	IP	34		

* Calculated wet efficiency.
 **For temperatures lower than recommended, use electrical pre-heater to ensure balanced operation.

Temperature efficiency (balanced mass flow) :
 Extract air = 20°C/60%RH
 Outdoor air = -7°C / 2°C / 7°C

RIS 1900PE EKO 3.0	Lwa total, dB(A)	LWA, dB(A)							
		125 Hz	250 Hz	500 Hz	1 kHz	2 kHz	4 kHz	8 kHz	
Supply	77	53	64	69	73	70	65	61	
Extract	68	42	58	64	62	61	58	55	
Surrounding	60	50	52	54	54	50	48	41	

Measured at 1938 m³/h, 100 Pa

Certifications

EUROVENT certified
 heat exchanger performance



RIS 1900PW EKO 3.0

Supply air

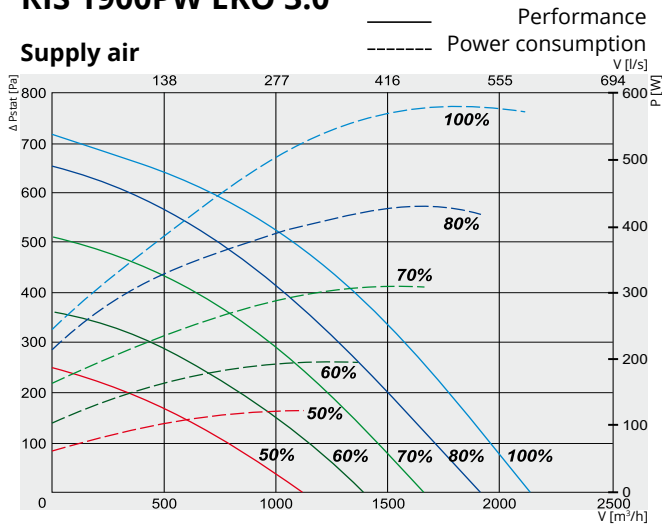

Exhaust air

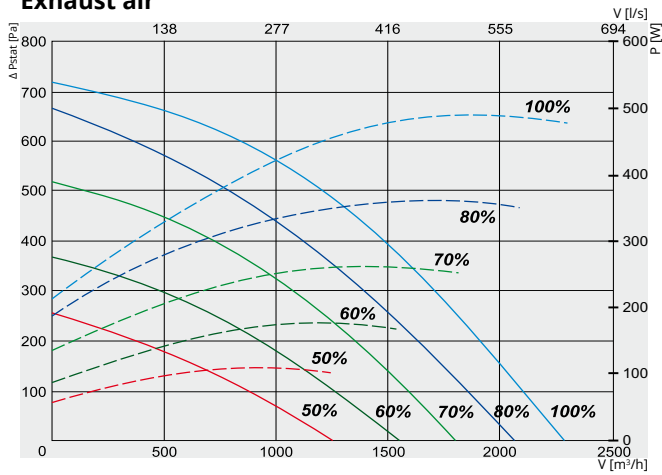

Specific fan power

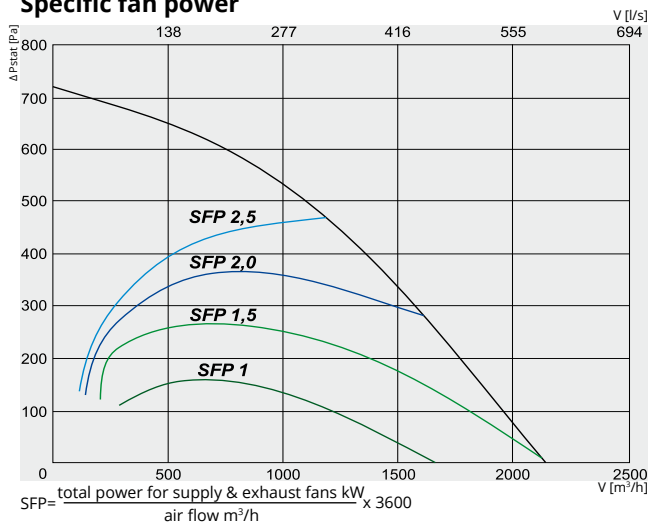

Temperature efficiency

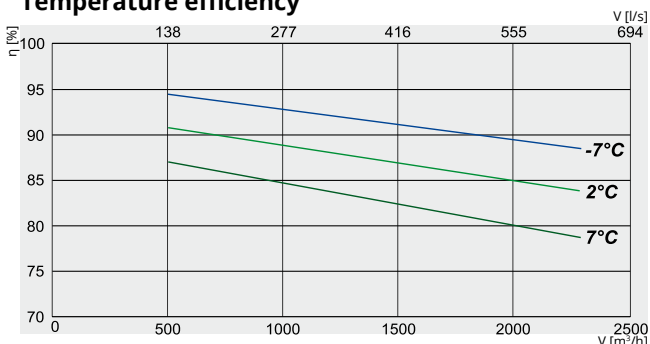

RIS 1900PW EKO 3.0

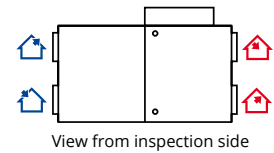

🏠 Exhaust air
 🏠 Extract air
 🏠 outdoor air
 🏠 Supply air

Article No. GAGRIS1753_0026A
 Version 1900PW EKO 3.0
 Optional water heater

1900PW EKO 3.0

Water heater (optional)	SVS 700x400		
Fans	phase/voltage	[50Hz/VAC]	~1, 230
exhaust	power/current	[kW/A]	0,485/3,12
	fan speed	[min ⁻¹]	2540
supply	power/current	[kW/A]	0,488/3,16
	fan speed	[min ⁻¹]	2540
Thermal efficiency up to*	90%		
Motorized by-pass	+		
Max power consumption	[kW/A]	0,97 /6,32	
Control board	PRV V2		
Filter class	exhaust/supply	M5/F7	
Housing insulation, mineral wool	[mm]	50	
Colour	RAL	grey	7040
Weight (net, without packing)	[kg]	269	
Comply with ERP	2016;2018		
Operation	indoors		
Fresh air temperature limits**	°C	-5 - +40	
Housing protection class	IP	34	

* Calculated wet efficiency.

**For temperatures lower than recommended, use electrical pre-heater to ensure balanced operation.

Temperature efficiency (balanced mass flow):
 Extract air = 20°C/60%RH
 Outdoor air = -7°C / 2°C / 7°C

RIS 1900PW EKO 3.0	Lwa total, dB(A)	LWA, dB(A)						
		125 Hz	250 Hz	500 Hz	1 kHz	2 kHz	4 kHz	8 kHz
Supply	77	53	64	69	73	70	65	61
Extract	68	42	58	64	62	61	58	55
Surrounding	60	50	52	54	54	50	48	41

Measured at 1938 m³/h, 100 Pa

Certifications

EUROVENT certified
 heat exchanger performance



RIS P EKO

RIS 2500PE EKO 3.0

Supply air

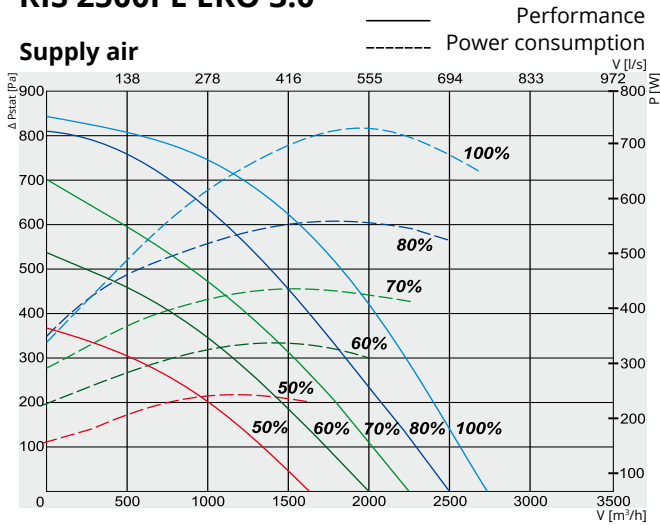

Exhaust air

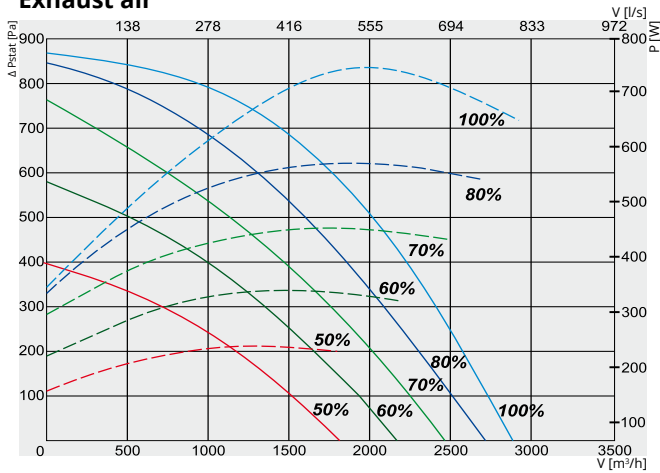

Specific fan power

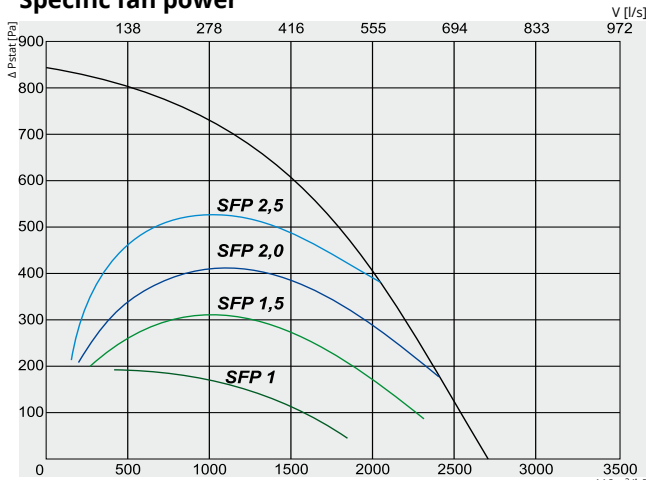

Temperature efficiency

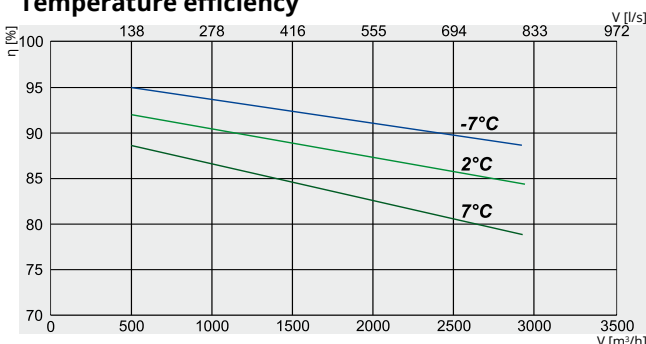

RIS 2500PE EKO 3.0

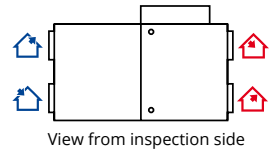

- Exhaust air
- Extract air
- outdoor air
- Supply air

Article No.	Version
GAGRIS1754_0027B	2500PE 4.5 EKO 3.0 Integrated electrical heater
GAGRIS1755_0028B	2500PE 9.0 EKO 3.0 Integrated electrical heater
GAGRIS1707_0015B	2500PE 18.0 EKO 3.0 Integrated electrical heater

		4.5 EKO 3.0	9.0 EKO 3.0	18.0 EKO 3.0
Electrical heater	phase/voltage [50Hz/VAC]	~3, 400	~3, 400	~3, 400
	[kW]	4,5	9,0	18,0
EC fans	phase/voltage [50Hz/VAC]	~1,230		
exhaust	power/current [kW/A]	0,725/3,24		
	fan speed [min ⁻¹]	2800		
supply	power/current [kW/A]	0,675/3		
	fan speed [min ⁻¹]	2800		
Thermal efficiency up to*		90%		
Motorized by-pass		+		
Max power consumption	[kW/A]	5,90 / 12,78	10,40 / 19,28	19,40 / 32,28
Control board		PRV V2		
Filter class	exhaust/supply	M5/F7		
Housing insulation, mineral wool	[mm]	50		
Colour	RAL	grey 7040		
Weight (net, without packing)	[kg]	322		
Comply with ERP		2016;2018		
Operation		indoors		
Fresh air temperature limits**	°C	-5 - +40		
Housing protection class	IP	34		

* Calculated wet efficiency.
 **For temperatures lower than recommended, use electrical pre-heater to ensure balanced operation.

Temperature efficiency (balanced mass flow) :
 Extract air = 20°C/60%RH
 Outdoor air = -7°C / 2°C / 7°C

RIS 2500PE EKO 3.0	Lwa total, dB(A)	125 Hz	250 Hz	500 Hz	1 kHz	2 kHz	4 kHz	8 kHz
Supply	80	60	68	72	75	74	71	65
Extract	69	56	60	64	63	60	58	41
Surrounding	62	46	54	56	57	54	50	45

Measured at 2548 m³/h, 102 Pa

Certifications

EUROVENT certified
 heat exchanger performance



AIR HANDLING UNITS

RIS 2500PW EKO 3.0

Supply air

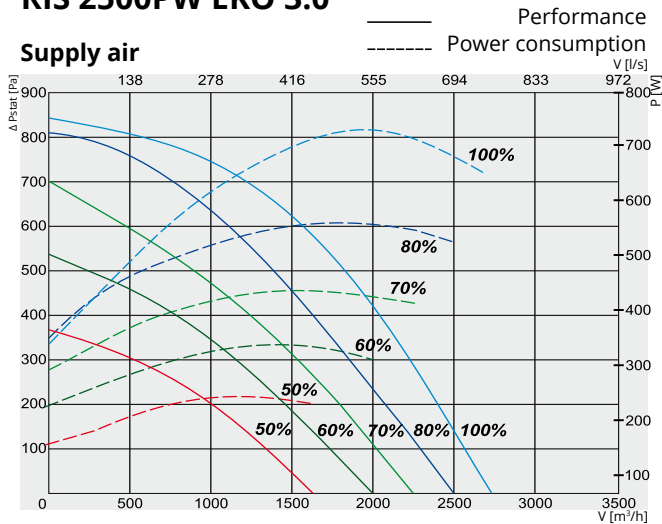

Exhaust air

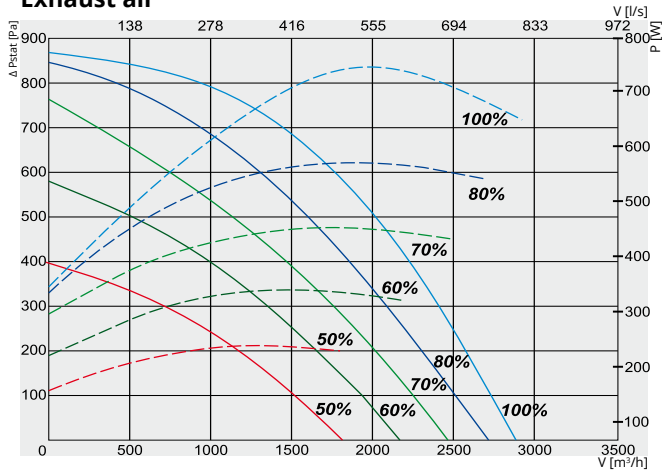

Specific fan power

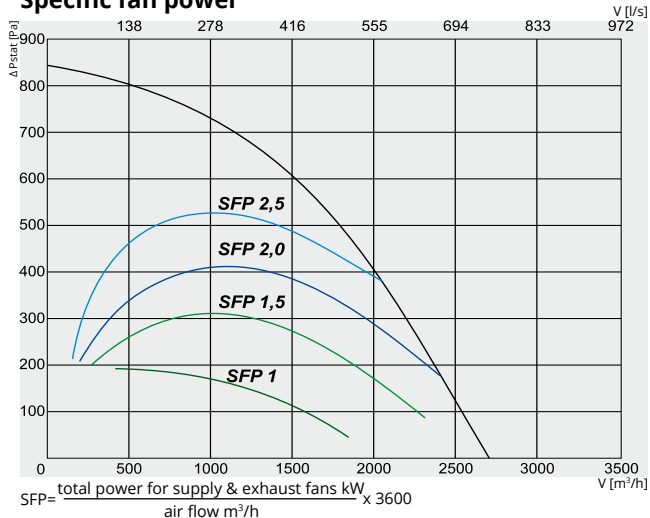

Temperature efficiency

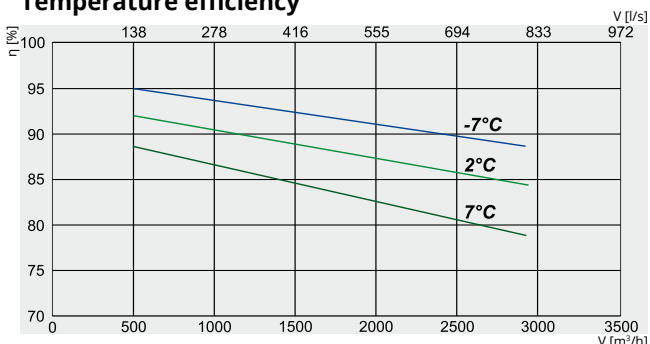

RIS 2500PW EKO 3.0

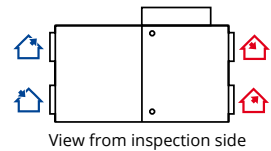

Exhaust air Extract air outdoor air Supply air

Article No. GAGRIS1756_0029A Version 2500PW EKO 3.0 Optional water heater

2500PW EKO 3.0

Water heater (optional)	phase/voltage	[50Hz/VAC]	SVS 700x400
Fans	phase/voltage	[50Hz/VAC]	~1, 230
exhaust	power/current	[kW/A]	0,725/3,24
	fan speed	[min ⁻¹]	2800
supply	power/current	[kW/A]	0,675/3
	fan speed	[min ⁻¹]	2800
Thermal efficiency up to*			90%
Motorized by-pass			+
Max power consumption	[kW/A]		1,40 /6,28
Control board			PRV V2
Filter class	exhaust/supply		M5/F7
Housing insulation, mineral wool		[mm]	50
Colour	RAL	grey	7040
Weight (net, without packing)		[kg]	322
Comply with ERP			2016;2018
Operation			indoors
Fresh air temperature limits**		°C	-5 - +40
Housing protection class	IP		34

* Calculated wet efficiency.

**For temperatures lower than recommended, use electrical pre-heater to ensure balanced operation.

Temperature efficiency (balanced mass flow):
Extract air = 20°C/60%RH
Outdoor air = -7°C / 2°C / 7°C

RIS 2500PW EKO 3.0	Lwa total, dB(A)	125 Hz	250 Hz	500 Hz	1 kHz	2 kHz	4 kHz	8 kHz
Supply	80	60	68	72	75	74	71	65
Extract	69	56	60	64	63	60	58	41
Surrounding	62	46	54	56	57	54	50	45

Measured at 2548 m³/h, 102 Pa

Certifications

EUROVENT certified
heat exchanger performance



RIS P EKO

RIS 400PE EKO 3.0 / RIS 700PE EKO 3.0 (ceiling mounted) versions with electrical heater

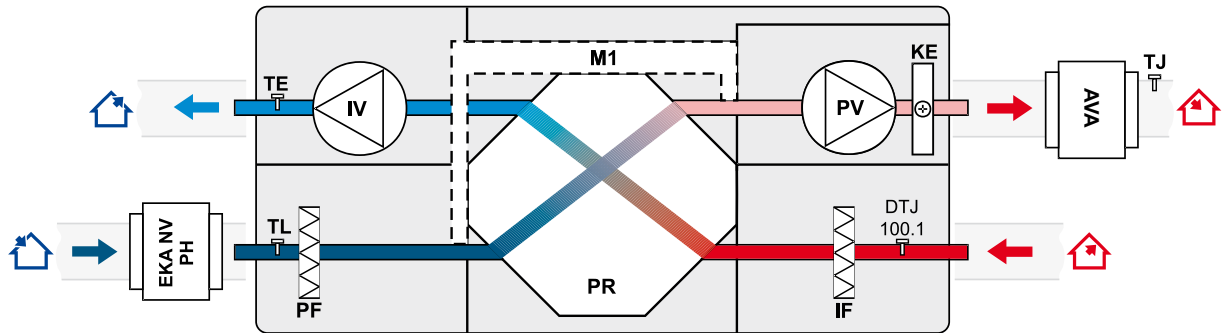

- IV - exhaust air fan
- PV - supply air fan
- PR - plate heat exchanger
- PF - filter for supply air (class F7)
- IF - filter for extract air (class M5)
- KE - electrical heater
- M1 - actuator of by-pass damper

- TL - fresh air temperature sensor
- TJ - supply air temperature sensor
- TE - exhaust air temperature sensor
- DTJ 100.1 - humidity + temperature sensor
- AVA - optionally supplied water cooler
- EKA NV PH - optional fresh air pre-heater

RIS 1200PE EKO 3.0 / 1900PE EKO 3.0 / 2500PE EKO 3.0 (ceiling mounted) versions with electrical heater

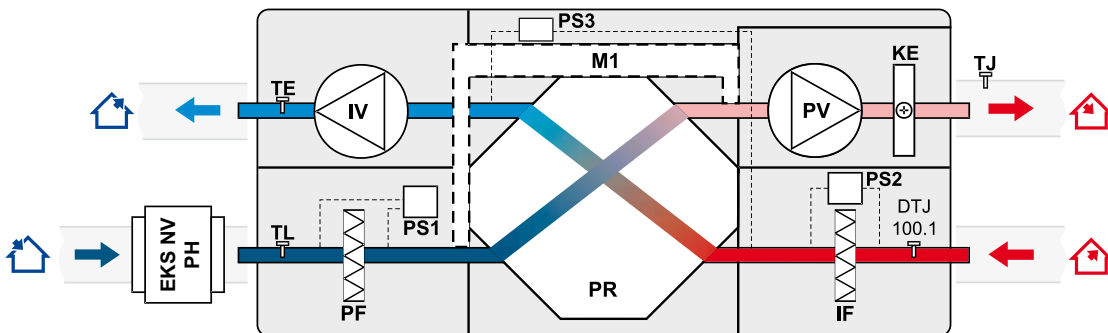

- IV - exhaust air fan
- PV - supply air fan
- PR - plate heat exchanger
- KE - electrical heater
- PF - filter for supply air (class F7)
- IF - filter for extract air (class M5)
- TE - temperature sensor for exhaust air
- TL - temperature sensor for fresh air

- EKS NV PH - optional fresh air pre-heater
- DTJ 100.1 - humidity + temperature sensor
- TJ - temperature sensor for supply air
- M1 - actuator of by-pass damper
- PS1 - supply air differential pressure switch
- PS2 - extract air differential pressure switch
- PS3 - heat exchanger antifrost pressure switch

RIS 400PW EKO 3.0 / RIS 700PW EKO 3.0 (ceiling mounted) versions with water heater

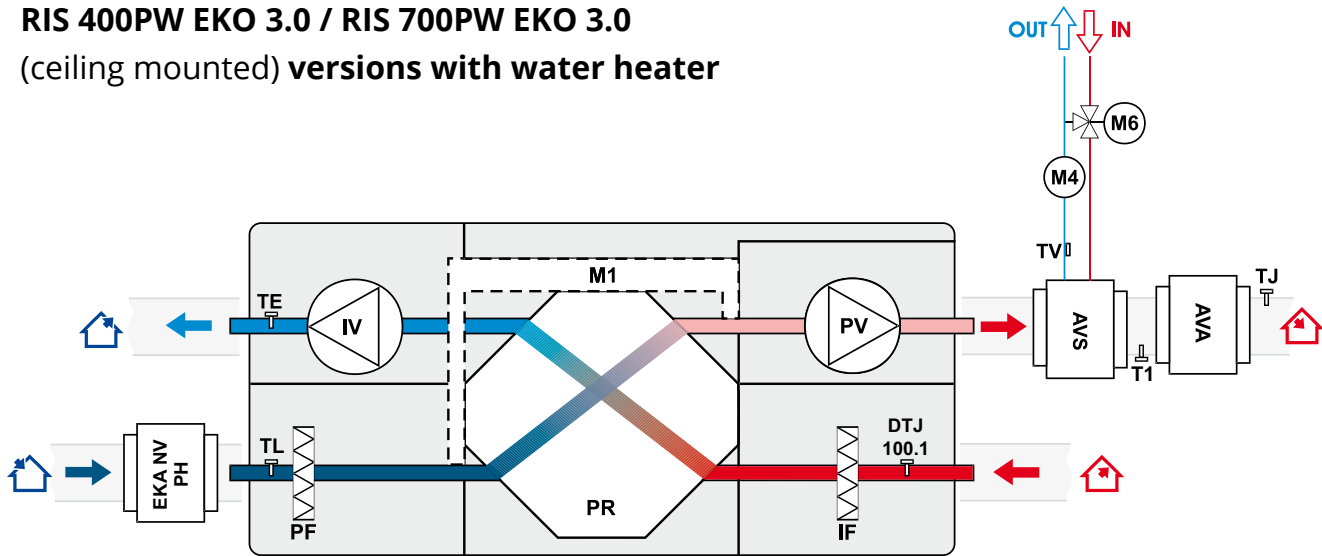

- IV** - exhaust air fan
- PV** - supply air fan
- PR** - plate heat exchanger
- PF** - filter for supply air (class F7)
- IF** - filter for extract air (class M5)
- TV** - antifrost sensor
- M1** - actuator of by-pass damper
- AVA** - optionally supplied water cooler

- M4** - water heater circulation pump
- M6** - optionally supplied mixing valve and motor
- TL** - fresh air temperature sensor
- TJ** - supply air temperature sensor
- TE** - exhaust air temperature sensor
- T1** - antifrost thermostat
- DTJ 100.1** - humidity + temperature sensor
- AVS** - optionally supplied water heater
- EKA NV PH** - optional fresh air pre-heater

RIS 1200PW EKO 3.0 / RIS 1900PW EKO 3.0 / 2500PW EKO 3.0 (ceiling mounted) versions with water heater

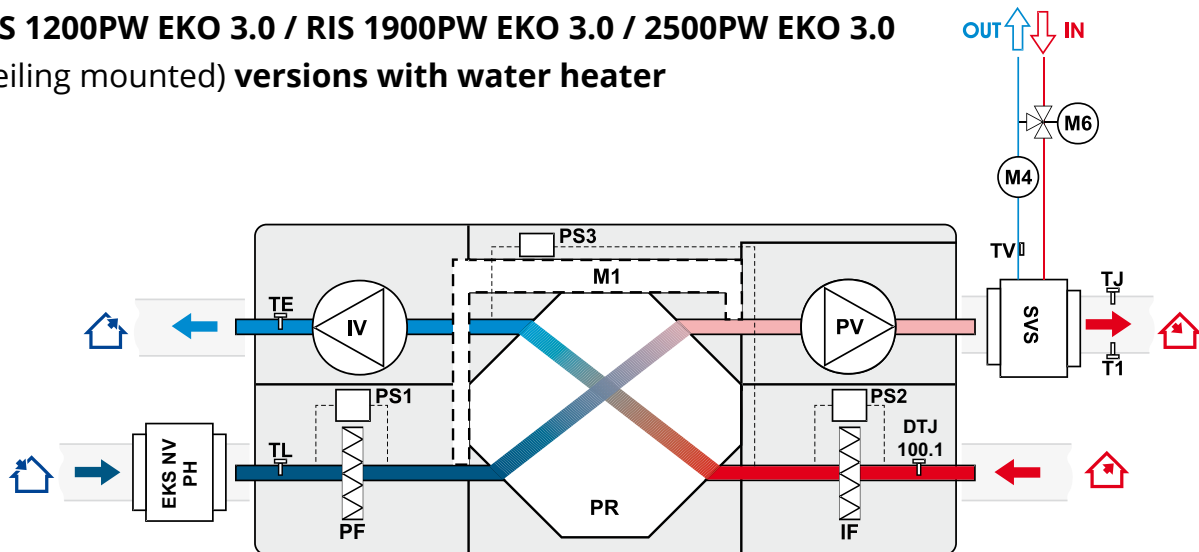

- IV** - exhaust air fan
- PV** - supply air fan
- PR** - plate heat exchanger
- PF** - filter for supply air (class F7)
- IF** - filter for extract air (class M5)
- TE** - temperature sensor for exhaust air
- TL** - temperature sensor for fresh air
- TJ** - temperature sensor for supply air
- T1** - antifrost thermostat

- TV** - antifrost sensor
- DTJ 100.1** - humidity + temperature sensor
- M1** - actuator of by-pass damper
- M4** - water heater circulation pump
- M6** - optionally supplied mixing valve and motor
- PS1** - supply air differential pressure switch
- PS2** - extract air differential pressure switch
- PS3** - heat exchanger antifrost pressure switch
- SVS** - optionally supplied water heater
- EKS NV PH** - optional fresh air heater

FUNCTIONS		PRV V2	
		RIS EKO 3.0	
		E	W
Description of the functions			
Functions			
	Date and time settings	✓	✓
	4 speeds for easy and user-friendly control ("Stop" - the unit is stopped; "Low", medium", and "High". Service menu allows adjusting each speed individually)	✓	✓
	BOOST function (Fans operate at highest speed)	✓	✓
	Comfortable air temperature function	✓	✓
	Cold/heat recovery	✓	✓
	Fire place function	✓	✓
	Dryness protection	✓	✓
	Weekly schedule	✓	✓
	Holiday schedule	✓	✓
	User and service control levels	✓	✓
	Manual air flow balancing	✓	✓
	CO₂ level indication and reduction function	✓	✓
	Night cooling function	✓	✓
	Relative humidity (RH) level indication and reduction function	✓	✓
	Software and configuration update possibility	✓	✓
	Supply air temperature control according to the extract air sensor	✓	✓
	Monitoring function (all sensors and I/O)	✓ ²	✓ ²
	Mode switch (start/stop)	✓	✓
	Extracted air relative humidity converter	✓	✓
	Manual components control	✓ ¹	✓ ¹
Functional units			
Fans			
	Soft start and stop	✓	✓
	Fan failure protection	✓	✓
	Speed synchronous/asynchronous 0-10V control	✓	✓
Electric heater			
	On/Off / PWM control	✓	
	Manual protection	✓	
	Overheat protection (additional protection software)	✓	✓
Water heater			
	Pulse-width modulation (PWM) valve actuator control		✓
	Protection using temperature sensor		✓
	Protection using thermostat (NC)		✓
	Circulation pump control		✓
	Return water temperature sensor	✓	✓
DX cooler			
	Control On/Off	✓	✓
Water cooler			
	Pulse-width modulation (PWM) valve actuator control		✓
	Control with three-positional valve actuator	✓	✓
Bypass damper			
	3-position actuator control	✓	✓
Filter pollution monitoring			
	By pressure switch (NC)	✓	✓
	By filter timer	✓	✓
Sensors			
	Supply air temperature sensor	✓	✓
	Fresh air temperature sensor	✓	✓
	Exhaust air temperature sensor	✓	✓
	Extract air temperature sensor	✓	✓
Emergency signals and inputs/outputs			
	Fire protection input	✓	✓
	Working indication output	✓	✓
	Alarm indication output	✓	✓
Remote controllers			
	Stouch	✓	✓
	Flex	✓	✓
	Ptouch	✓	✓
	MB-Gateway	✓	✓

1 With FLEX TEST remote controller

2 Only sensors